

Aluminum:

The ALU-Frame is new to our product range and is equipped with our own reliable high quality linen. The high quality ALU-Frame provides the foundation for professional artists, galleries and museums. By using an aluminum frame, warping in dry or low moisture environments is now a thing of the past.

Our precisely engineered components and years of experience in developing aluminium frames means that we can guarantee high quality products.

Aluminum has been available for just over one hundred years and in this time has conquered the world. Economically speaking it is a very important metal. It is light (only one third the weight of steel or bronze) but just as strong, durable and non-corrosive. In addition it is strong and lightweight.

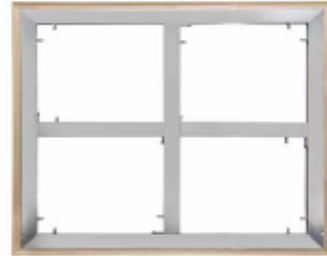

Corner connector

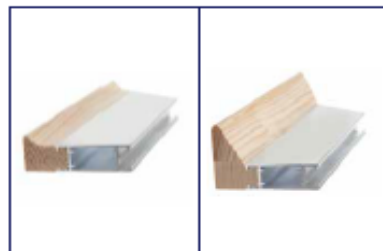

25mm

45mm



Cross



Corner connector



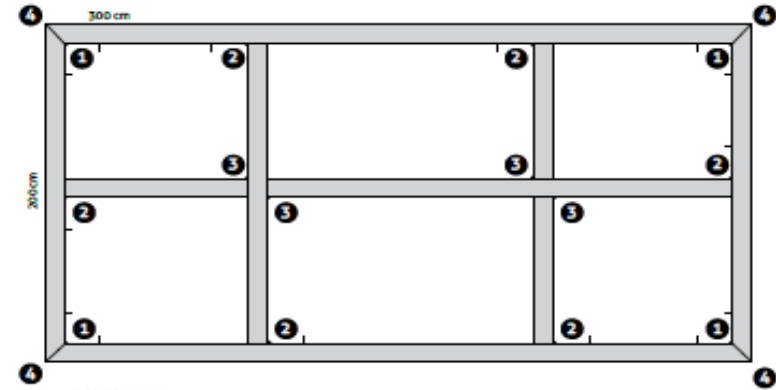

- 1  ALU-Frame does not warp nor bend
- 2  Maximum stability
- 3  Easy to transport
- 4  Light weight

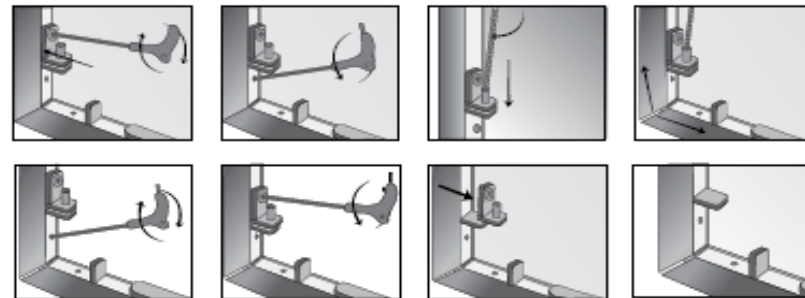

- 1  Corner connector
- 2  Support connector
- 3  Cross connector
- 4  Internal stabilizer (advised $\geq 200 \times 200$ cm)

Below you see a simple instruction on how to restretch a ALU-Frame.

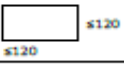
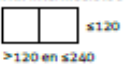
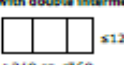
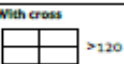
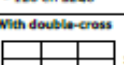
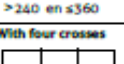
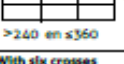
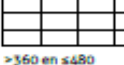

- 5  "Unlimited" dimensions
- 6  Made to measure, possible on standard machinery
- 7  Sustainable product
- 8  Eco friendly

	Corner connector	Support connector	Cross connector
Without cross bars  ≤120 ≤120	4	-	-
With Intermediate bar  ≤120 >120 en ≤240	4	2	-
With double intermediate bars  ≤120 >240 en ≤360	4	4	-
With cross  >120 en ≤240 >120 en ≤240	4	4	2
With double-cross  >120 en ≤240 >240 en ≤360	4	6	4
With four crosses  >240 en ≤360 >240 en ≤360	4	8	8
With six crosses  >240 en ≤360 >360 en ≤480	4	10	12
With nine crosses  >360 en ≤480 >360 en ≤480	4	12	18

 AL025 - ALU-Frame bar 25mm (25x65 mm)	
 AL045 - ALU-Frame bar 45mm (45x65 mm)	
 ALSUP - Cross bars (18x45 mm)	

The stabilizer can be assembled inside the aluminum box profile.



ALU-frame corner stabilizer

Itemcode	
Corner connector ALCORNER - Box (48pcs.)	
Support connector ALCONNECT - Box (48pcs.)	
Cross connector ALCROSS - Box (48pcs.)	
Spanner ALSTRETCH - Box (48pcs.)	
Screw eyelets ALHANGER - Box (48pcs.)	
Heavy duty hanger ALHEAVY - Box (48pcs.)	
Angle ALANGLE - Box (48pcs.)	
Allen key, 4mm ALINBUS - Box (48pcs.)	
Extender 25 mm AL25EXT - Box (48pcs.)	
Extender 45 mm AL45EXT - Box (48pcs.)	